

YEARS: 2015-PRESENT

MAKE: AUDI

MODEL: Q3

STYLE: CROSSOVER

WARNING: NEVER EXCEED YOUR VEHICLE MANUFACTURER'S RECOMMENDED TOWING CAPACITY
 For more information log onto www.curtmfg.com & for helpful towing tips log onto www.hitchinfo.com

WEIGHT CARRYING:
 TRAILER WEIGHT: 3500 LBS.
 TONGUE WEIGHT: 525 LBS.

WARNING:
 WE RECOMMEND THE USE OF 18050 STABILIZING STRAPS FOR ALL NON-TRAILER (WHEEL-LESS) LOADS. PLEASE SEE THE CURT CATALOG OR VISIT US ONLINE AT WWW.CURTMFG.COM FOR FURTHER INFORMATION.

PRO INSTALL TIME: 45 MIN.
NOVICE INSTALL TIME: 90 MIN.

IF YOU ARE HESITANT TO UNDERTAKE THIS TASK ON YOUR OWN, CONTACT AN AUTHORIZED CURT INSTALLER FOR ADDITIONAL ASSISTANCE.

INSTALLATION TIPS:

- BEFORE YOU BEGIN INSTALLATION, READ ALL INSTRUCTIONS THOROUGHLY.
- TO EASE INSTALLATION, 2 PEOPLE MAY BE REQUIRED.
- USING PROPER TOOLS WILL GREATLY IMPROVE THE QUALITY OF THE INSTALL AND REDUCE THE TIME REQUIRED.
- NEED HELP OR HAVE SOME QUESTIONS? CALL TECHNICAL SUPPORT AT 800.798.0813



INSTALLATION REQUIRES:

SAFETY GLASSES	AVIATION SHEARS	TORQUE WRENCH
13mm 3/4" SOCKET	8" SOCKET EXTENSION	RATCHET
T27 TORXBIT SOCKET	DIE GRINDER	

LEVEL OF DIFFICULTY: MODERATE

EASY	MODERATE	CHALLENGING
	HOLE ENLARGEMENT REQUIRED	
	LOWER EXHAUST	
	FISHWIRE TECHNIQUE	
	TRIM EXHAUST HEAT SHIELD AND REAR FASCIA	

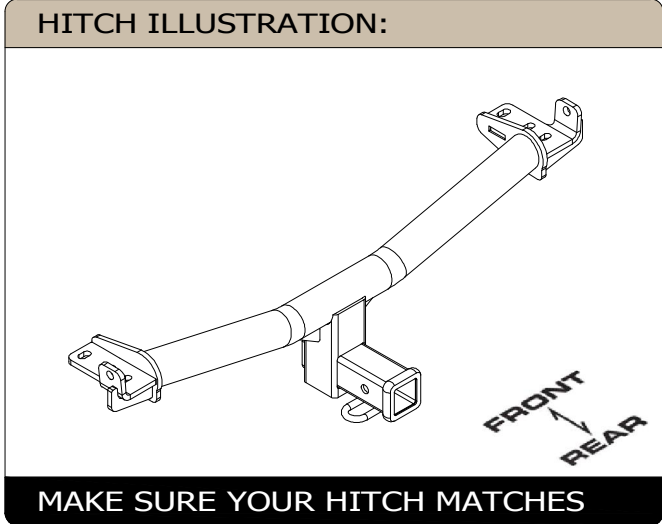

SCAN FOR MORE INFO

PERIODICALLY CHECK THIS RECEIVER HITCH TO ENSURE ALL FASTENERS ARE TIGHT AND ALL STRUCTURAL COMPONENTS ARE SOUND

CURT Manufacturing LLC. warrants this product to be free of defects in material and/or workmanship at the time of retail purchase by the original purchaser. If the product is found to be defective, CURT Manufacturing LLC. may repair or replace the product at their option, when the product is returned, prepaid, with proof of purchase. Alteration to, misuse of, or improper installation of this product voids the warranty. CURT Manufacturing LLC.'s liability is limited to repair or replacement of products found to be defective, and specifically excludes liability for incidental or consequential loss or damage.

For more information log onto www.curtmfg.com , & for helpful towing tips log onto www.hitchinfo.com

This product complies with safety specifications and requirements for connecting devices and towing systems of the state of New York, V.E.S.C.Regulation V-5 and SAE J684.

INSTALLATION WALKTHROUGH:

Parts List				
ITEM	QTY	PART NUMBER	DESCRIPTION	
1	6	1_2 FISHWIRE	1/2" FISHWIRE	
2	2	CM-SP56	.375 x 1.25 x 2.00" ROUND HOLE SPACER	
3	6	1/2-13 x 1 1/2	CARRIAGE BOLT	
4	6	CM-SP10	.250 x 1.00 x 2.50" SQUARE HOLE SPACER	
5	6	HFN 1213	HEX FLANGE NUT	

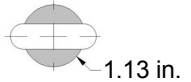

HOLE ENLARGEMENT DIAGRAM

FISHWIRE TECHNIQUE

INSERT COILED END OF FISHWIRE TOOL THROUGH HITCH MOUNTING HOLE IN VEHICLE FRAME RAIL AND OUT THE ACCESS HOLE. PASS COILED END OF FISHWIRE THROUGH SPACER AND THREAD BOLT INTO COIL. KINK WIRE TO KEEP SPACER SEPARATE FROM BOLT AS SHOWN. PULL FISHWIRE, SPACER, AND BOLT THROUGH FRAME AND OUT MOUNTING HOLE. USE FISHWIRE TO GUIDE HITCH DURING MOUNTING AND PREVENT LOSS OF BOLT / SPACER INSIDE FRAME RAIL.

NOTE: SOME VEHICLES MAY FISHWIRE THROUGH END OF FRAME

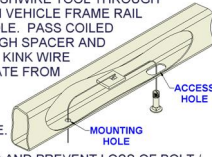

REVERSE PULL FISHWIRE TECHNIQUE

ATTACH FISHWIRE TO CARRIAGE BOLT AND SLIDE SPACER ONTO FISHWIRE. PUSH THE BOLT THRU THE HOLE FOLLOWED BY THE SPACER (AS SHOWN). PULL BOLT BACK INTO POSITION, PROTRUDING FROM THE FRAME.

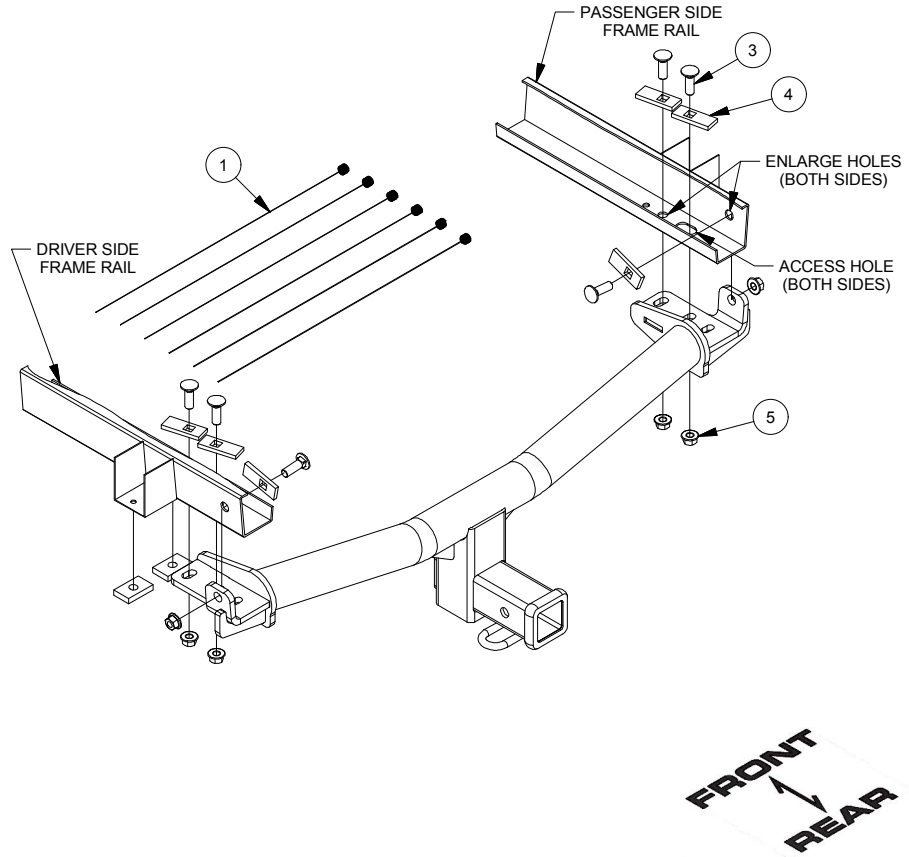
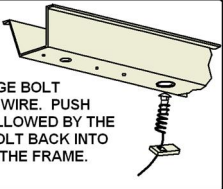

1. Remove (2) fasteners centered along the bottom of the rear bumper cover using a T27 socket.

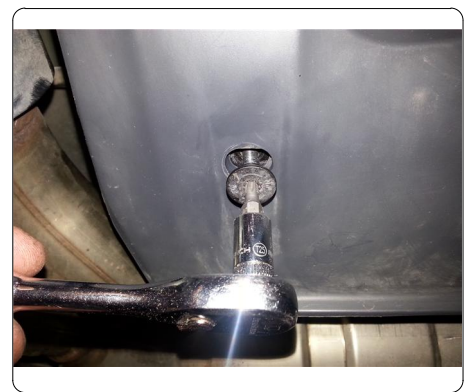

2. Remove (2) M8 fasteners for the driver side exhaust bracket, and (2) M8 fasteners for the muffler hangers using a 13mm socket. Support the muffler to prevent damage to the exhaust.

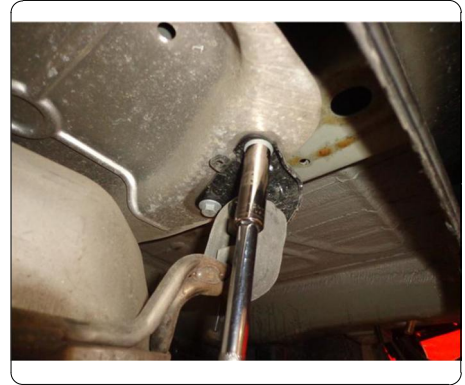
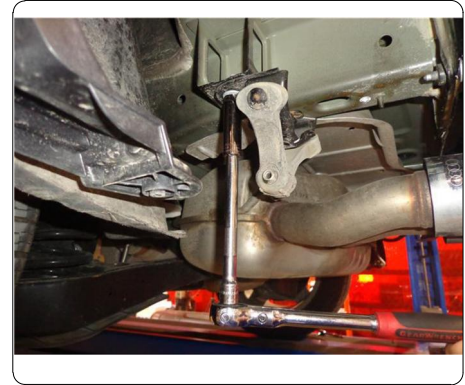

INSTALLATION WALKTHROUGH:

3. Remove (1) bolt for the heat shield using a 13mm socket and (1) speed nut to remove the heat shield. Cut a notch in the heat shield to clear the forwardmost mounting hole on the driver side frame rail using aviation shears. Reinstall the heat shield using the bolt and speed nut.

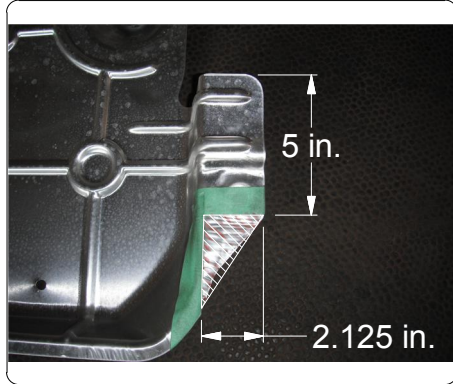

4. Enlarge the attachment holes along the bottom of each frame rail and the hole on the outside of each frame rail. Fishwire 1/2" carriage bolts and SP10 spacers through the access hole to the forwardmost hole and outside holes on each frame rail.

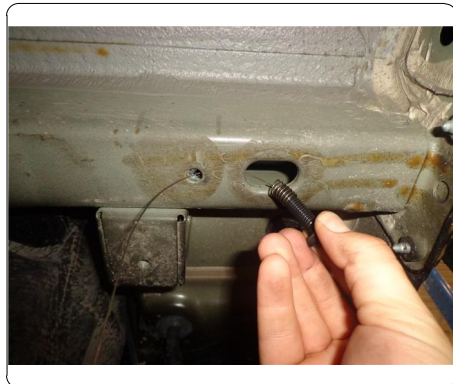

5. Reverse fishwire 1/2" carriage bolts and SP10 spacers through the access hole. Carefully pull bumper cover and raise hitch into position. Loosely fasten the hitch using 1/2" flange nuts on both sides.

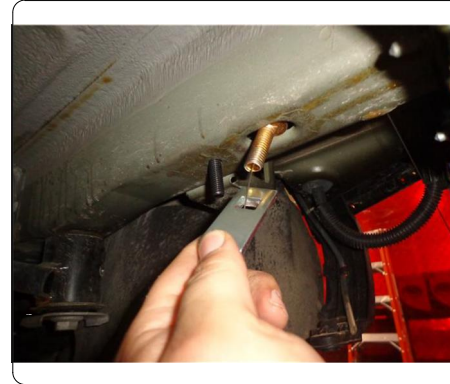

6. Torque all 1/2" hardware to 110 ft-lbs.

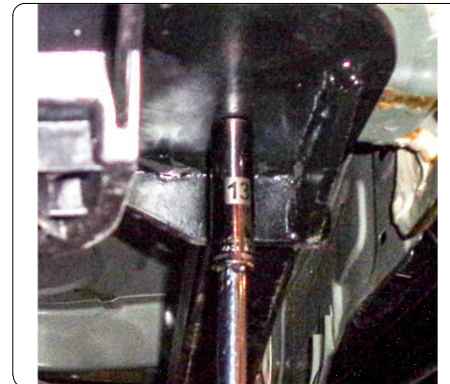

INSTALLATION WALKTHROUGH:

7. Raise exhaust brackets and secure by placing the provided CM-SP56 spacers between the driver side exhaust bracket and the frame using the existing fastener removed in Step (4).

Torque factory M8 hardware to 20 ft-lbs.



8. Trim a 3-1/2" square section from the center at the bottom of the bumper fascia using aviation shears.

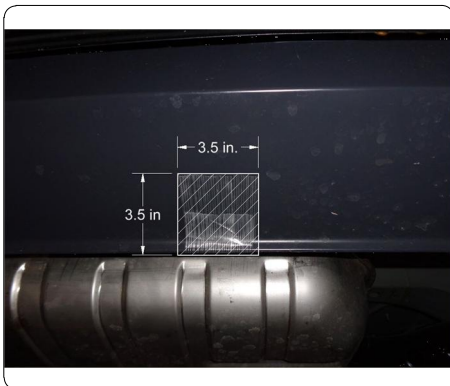

9. Reinstall bumper cover fasteners removed in Step (1).
Installation complete.



TOWING SAFETY INFORMATION

Gross Trailer Weight / GTW

The Gross Trailer Weight is the weight of the trailer & cargo. Measure this by putting the fully loaded trailer on a vehicle scale.



Tongue Weight / TW

The downward force that is exerted on the hitch ball by the coupler. The tongue weight will vary depending on where the load is positioned in relationship to the trailer axle(s). To measure the tongue weight, use either a commercial scale or a bathroom scale with the coupler at towing height. When using a bathroom scale with heavier tongue weights, use the method shown and multiply the scale reading by 3.

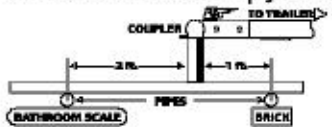

Weight Carrying / WC

The total weight of both the trailer and the cargo inside. Never exceed the weight capacity of your trailer hitch.

Weight Distribution / WD

Used to balance the weight of the cargo between the front and rear wheels throughout the trailer, allowing for better steering, braking, and level riding.



Sway Control

A device used to reduce the lateral movements of the trailer that are caused by the wind. This works in conjunction with a weight distribution hitch. Do not use this on a class 1 or 2 hitch, or with surge brakes.

How Much Can You Safely Tow?

TONGUE WEIGHT (lb.)	1000	2000	3000	4000	5000	6000	7000	8000	10,000	12,000	
CLASS 1	CLASS 1										
CLASS 2	CLASS 2										
CLASS 3	CLASS 3										
CLASS 4	CLASS 4										
CLASS 5	CLASS 5										
Coupler	11	12	13	14	15	16					
Inc.	1100	1200	1300	1400	1500	1600					
Weight	17	18	19	20	22	24	26	28	30	32	
Inc.	2100	2400	2700	3000	3300	3600	3900	4200	4500	4800	
Weight	14	15	16	17	18	19	20	21	22	23	
Inc.	2800	3200	3600	4000	4400	4800	5200	5600	6000	6400	
5th Wheel											

Refer to owner's manual for towing capabilities and limitations.

Ball Mount

The ball mount is placed inside the opening of the receiver hitch which is mounted to the vehicle. Make sure a hitch pin and clip is properly securing the ball mount to the receiver hitch before you begin towing.

- A: Rise. B: Drop. C: Hole Size. D: Length.

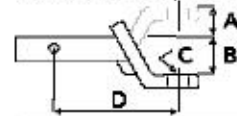

Trailer Ball

The connection from the hitch to the trailer. There are many factors that determine the correct hitch ball:

- Number one is the hitch ball's gross trailer weight rating.
- The mounting platform must be at least 3/8" thick.
- The hole diameter must not be more than 1/16" larger than the threaded shank.
- Every time you tow, check the nut and lock washer to make sure they are fastened securely.
- A: Ball Dia. B: Shank Length. C: Shank Dia. D: Shank Rise.

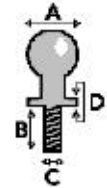

Coupler

The component that is placed over the trailer ball to connect the vehicle to the trailer. Be sure that the coupler size matches the size of the hitch ball and that the coupler handle is securely fastened. To determine what size hitch ball you need for your application you will need to know the size of coupler that is on the trailer. Be sure your coupler is properly adjusted to the ball you are using.

NOTE: For added security the use of safety devices such as Coupler Safety Pins and Locks is strongly recommended.

Safety Chains

Safety chains are a requirement and should be crossed under the tongue of the trailer so that the tongue will not drop to the road if it becomes separated from the hitch. Always leave enough slack so you can turn. Never allow the safety chains to drag on the ground and never attach the chains to the bumper.

Trailer Classification: Safety Chain Breaking Force - Minimum

Class 1: 2,000 lbs. (8.9 kN)

Class 2: 3,500 lbs. (15.6 kN)

Class 3: 5,000 lbs. (22.2 kN)

The strength rating of each length of safety chain or its equivalent and its attachments shall be equal to or exceed in minimum breaking force the GVWR (Gross Vehicle Weight Rating) of the trailer.

Electrical

Trailer lights, Electric Brakes, Break-away systems - Every time you tow, be sure to check that all components are working properly.

Wiring identification by color:

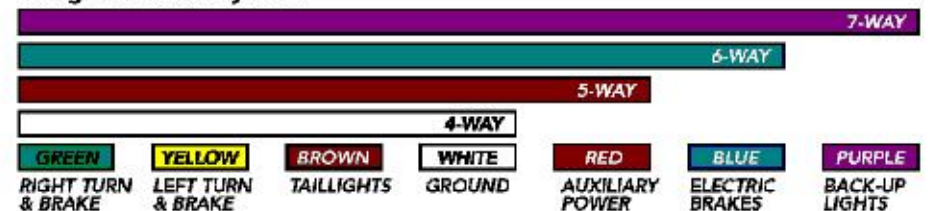

CURT DISCLAIMER: WIRING COLOR SHOWN WORK IN CONJUNCTION WITH CURT MANUFACTURING PRODUCTS.

13238

AUDI Q3

12/11/2015

PAGE 1 of 2

GROSS LOAD CAPACITY WHEN USED AS A WEIGHT CARRYING HITCH: 3500 LBS. TRAILER WEIGHT & 525 LBS. TONGUE WEIGHT.

DO NOT EXCEED VEHICLE MANUFACTURER'S RECOMMENDED TOWING CAPACITY.

WARNING: ALL NON-TRAILER LOADS APPLIED TO THIS PRODUCT MUST BE SUPPORTED BY 18050 STABILIZING STRAPS.

** FAILURE TO PROPERLY SUPPORT NON-TRAILER LOADS WILL VOID PRODUCT WARRANTY**

HAVING INSTALLATION QUESTIONS? CALL TECHNICAL SUPPORT AT 1-800-798-0813

Parts List			
ITEM	QTY	PART NUMBER	DESCRIPTION
1	6	1_2 FISHWIRE	1/2" FISHWIRE
2	2	CM-SP56	.375 x 1.25 x 2.00" ROUND HOLE SPACER
3	6	1/2-13 x 1 1/2	CARRIAGE BOLT
4	6	CM-SP10	.250 x 1.00 x 2.50" SQUARE HOLE SPACER
5	6	HFN 1213	HEX FLANGE NUT

REVERSE PULL FISHWIRE TECHNIQUE

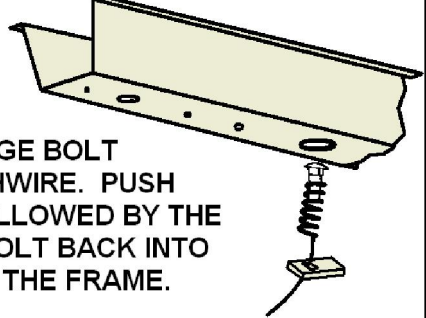

ATTACH FISHWIRE TO CARRIAGE BOLT AND SLIDE SPACER ONTO FISHWIRE. PUSH THE BOLT THRU THE HOLE FOLLOWED BY THE SPACER (AS SHOWN). PULL BOLT BACK INTO POSITION, PROTRUDING FROM THE FRAME.

FISHWIRE TECHNIQUE

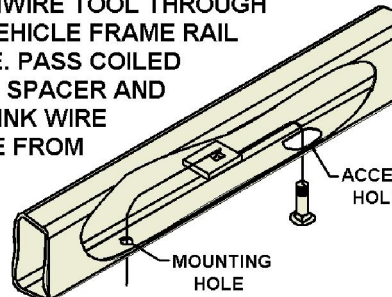

INSERT COILED END OF FISHWIRE TOOL THROUGH HITCH MOUNTING HOLE IN VEHICLE FRAME RAIL AND OUT THE ACCESS HOLE. PASS COILED END OF FISHWIRE THROUGH SPACER AND THREAD BOLT INTO COIL. KINK WIRE TO KEEP SPACER SEPERATE FROM BOLT AS SHOWN. PULL FISHWIRE, SPACER, AND BOLT THROUGH FRAME AND OUT MOUNTING HOLE. USE FISHWIRE TO GUIDE HITCH DURING MOUNTING AND PREVENT LOSS OF BOLT / SPACER INSIDE FRAME RAIL.

NOTE: SOME VEHICLES MAY FISHWIRE THROUGH END OF FRAME

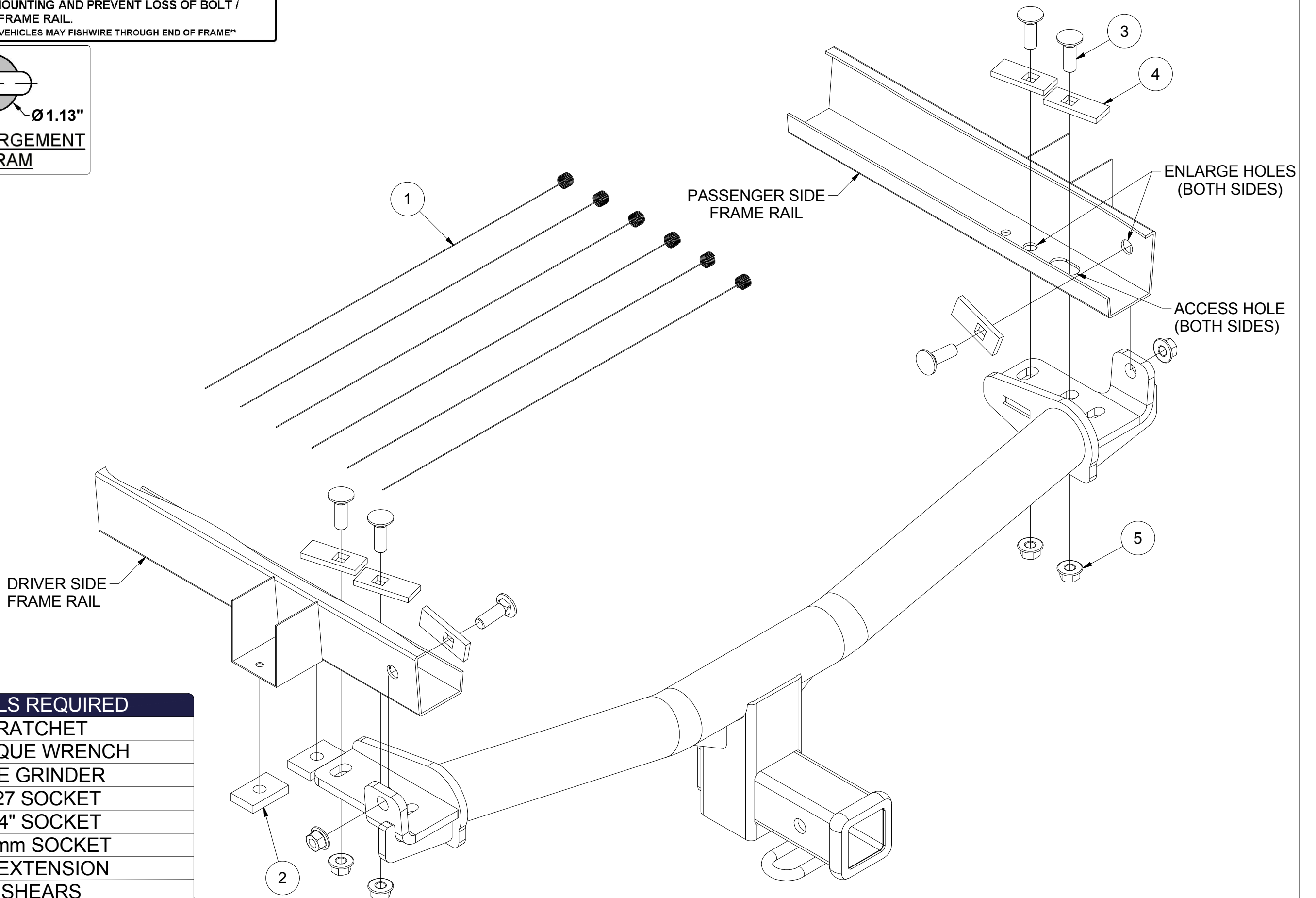
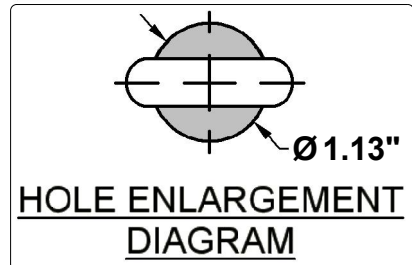

TOOLS REQUIRED

RATCHET
TORQUE WRENCH
DIE GRINDER
T27 SOCKET
3/4" SOCKET
13mm SOCKET
8" EXTENSION
SHEARS

HITCH WEIGHT: 31 LBS.
 INSTALL TIME
 PROFESSIONAL: 45 MINUTES
 NOVICE (DIY): 90 MINUTES
 INSTALL NOTES:
 -FASCIA TRIM REQUIRED
 -HOLE ENLARGEMENT REQUIRED
 -LOWER EXHAUST
 -FISHWIRE HARWARE

FRONT
REAR

PERIODICALLY CHECK THIS RECEIVER HITCH TO ENSURE THAT ALL FASTENERS ARE TIGHT AND THAT ALL STRUCTURAL COMPONENTS ARE SOUND.



Scan for more information

CURT Manufacturing LLC., warrants this product to be free of defects in material and/or workmanship at the time of retail purchase by the original purchaser. If the product is found to be defective, CURT Manufacturing LLC., may repair or replace the product, at their option, when the product is returned, prepaid, with proof of purchase. Alteration to, misuse of, or improper installation of this product voids the warranty. CURT Manufacturing LLC.'s liability is limited to repair or replacement of products found to be defective, and specifically excludes liability for incidental or consequential loss or damage.

HAVING INSTALLATION QUESTIONS? CALL TECHNICAL SUPPORT AT 1-800-798-0813

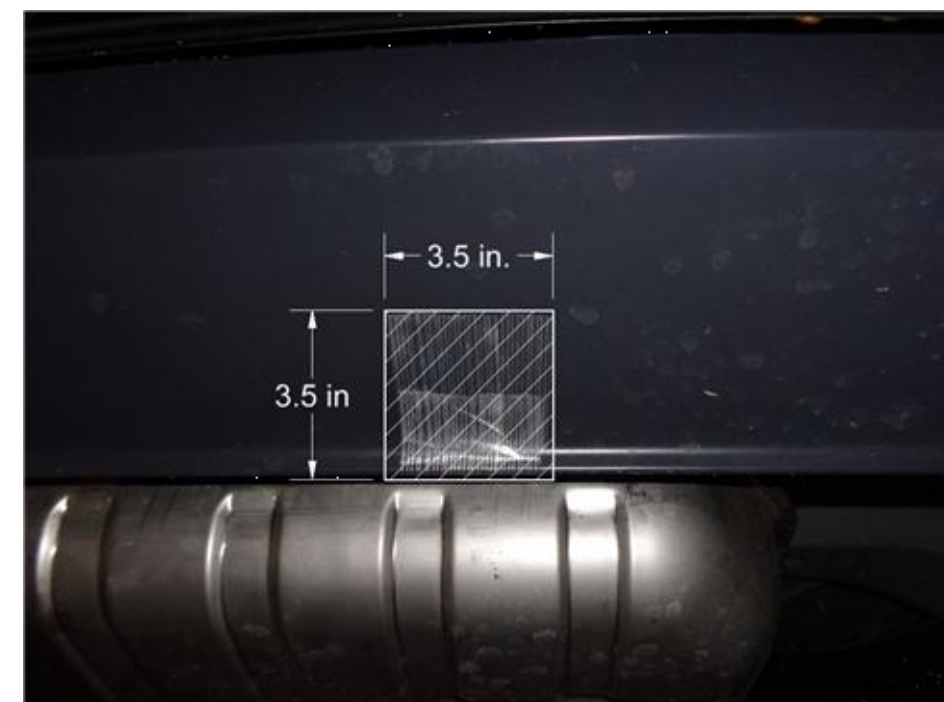
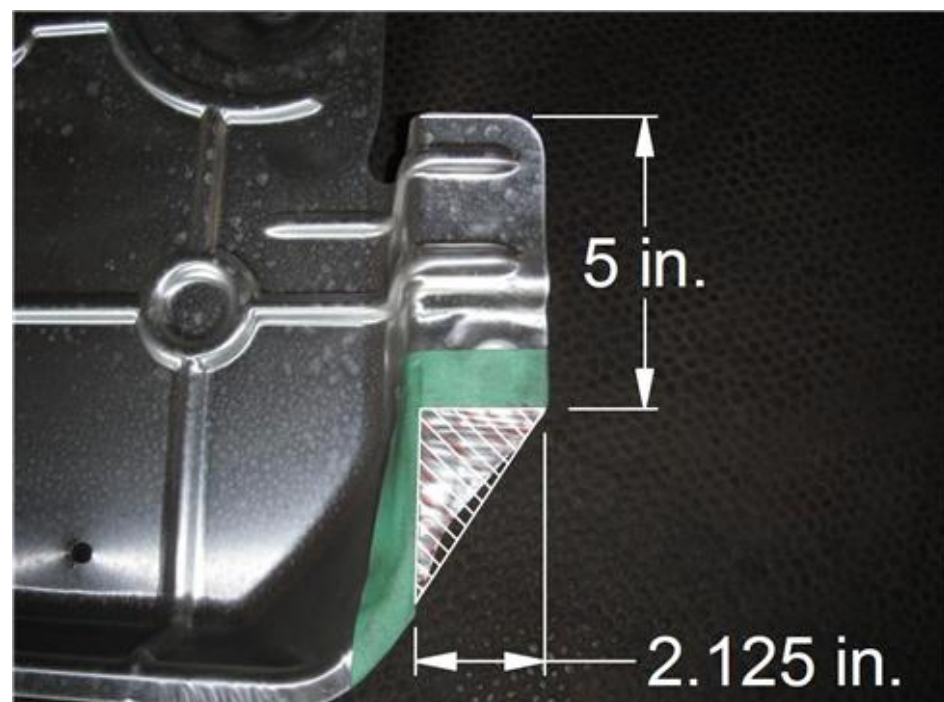
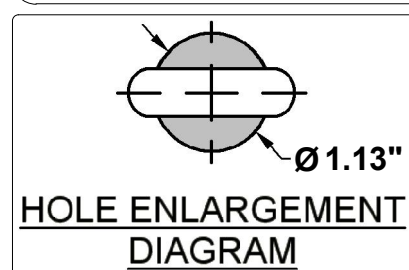

INSTALLATION STEPS

1. Remove (2) fasteners centered along the bottom of the rear bumper cover using a T27 socket.
2. Remove (2) M8 fasteners for the driver side exhaust bracket, and (2) M8 fasteners for the muffler hangers using a 13mm socket. Support the muffler to prevent damage to the exhaust.
3. Remove (1) bolt for the heat shield using a 13mm socket and (1) speed nut to remove the heat shield. Cut a notch in the heat shield to clear the forwardmost mounting hole on the driver side frame rail using aviation shears. Reinstall the heat shield using the bolt and speed nut.
4. Enlarge the forwardmost hole along the bottom of each frame rail and the hole on the outside of each frame rail. Fishwire 1/2" carriage bolts and SP10 spacers through the access hole to the forwardmost hole and outside holes on each frame rail.
5. Reverse fishwire 1/2" carriage bolts and SP10 spacers through the access hole. Carefully pull bumper cover and raise hitch into position. Loosely fasten the side plates with 1/2" flange nuts on both sides.
6. Torque all 1/2" hardware to 110 ft-lbs.
7. Raise exhaust brackets and secure by placing the provided CM-SP56 spacers between the driver side exhaust bracket and the frame using existing fastener removed in Step (4). Torque factory M8 hardware to 20 ft-lbs.
8. Trim a 3-1/2" square section from the center at the bottom of the bumper fascia using aviation shears.
9. Reinstall bumper cover fasteners removed in Step (1).

Installation complete.

PERIODICALLY CHECK THIS RECEIVER HITCH TO ENSURE THAT ALL FASTENERS ARE TIGHT AND THAT ALL STRUCTURAL COMPONENTS ARE SOUND.

CURT Manufacturing LLC., warrants this product to be free of defects in material and/or workmanship at the time of retail purchase by the original purchaser. If the product is found to be defective, CURT Manufacturing LLC., may repair or replace the product, at their option, when the product is returned, prepaid, with proof of purchase. Alteration to, misuse of, or improper installation of this product voids the warranty. CURT Manufacturing LLC.'s liability is limited to repair or replacement of products found to be defective, and specifically excludes liability for incidental or consequential loss or damage.